

DIMM sockets are only available as long latch type
(Module locking extractors).

Insertion & extraction of the module can be made without any tools.

Positive polarization prevents wrong insertion of the module.

Contacts are designed with an anti-overstress feature for long contact life. Selective Gold/Tin plated. Gold only in contact area.

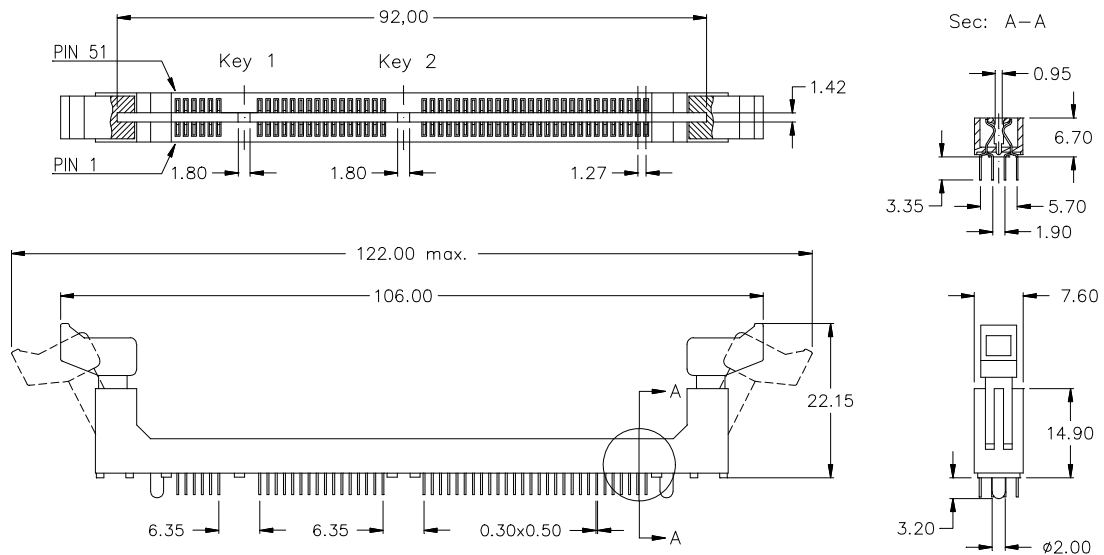
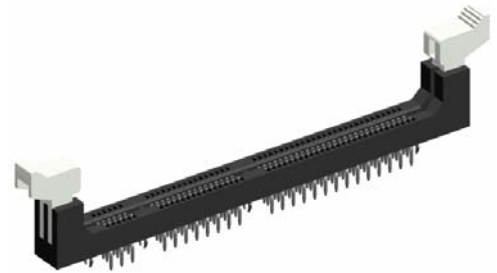

PC Board hole layout

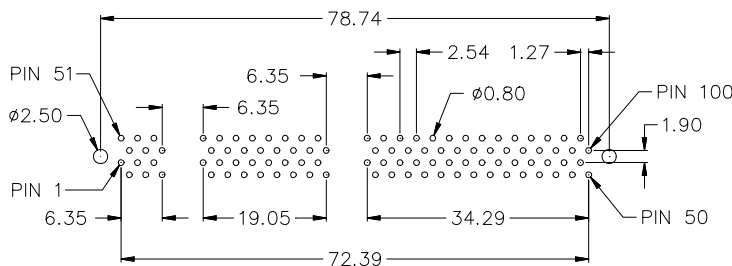

Module keying Type "A"

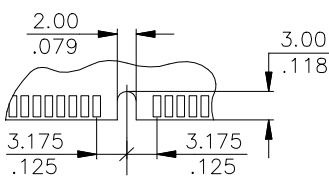

Module keying Type "B"

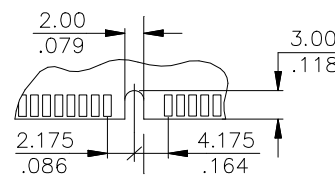

Module keying Type "C"

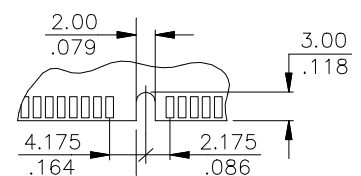

Specification

Current rating	1 A max., 250V AC	Operating temperature	-55° C to +105° C min.
Contact resistance	30 mΩ max.	Insulator (RoHS compliant)	high temp plastic UL 94 V-0
Breakdown voltage	1,5 KV RMS max.	Contact (RoHS compliant)	Copper Alloy
Insulation resistance	10 ⁴ MΩ min.	Plating	Au / Sn (leadfree) over Ni
Capacitance	1 pF max.		

Pin	Socket Type	Key No. 1	Key No. 2	Ordering Code
100 pin	DRAM 5 Volt	Type "A"	Type "B"	Please contact E-tec sales office for availability.
100 pin	SDRAM 5 Volt	Type "B"	Type "B"	Please contact E-tec sales office for availability.
100 pin	UDRAM 5 Volt	Type "C"	Type "B"	Please contact E-tec sales office for availability.
100 pin	DRAM 3,3 Volt	Type "A"	Type "A"	Please contact E-tec sales office for availability.
100 pin	SDRAM 3,3 Volt	Type "B"	Type "A"	Please contact E-tec sales office for availability.
100 pin	UDRAM 3,3 Volt	Type "C"	Type "A"	DM1 - 100 - VCA9 - 95/1L

DIMM sockets are only available as long latch type
(Module locking extractors).

Insertion & extraction of the module can be made without any tools.

Positive polarization prevents wrong insertion of the module.

Contacts are designed with an anti-overstress feature for long contact life. Selective Gold/Tin plated. Gold only in contact area.

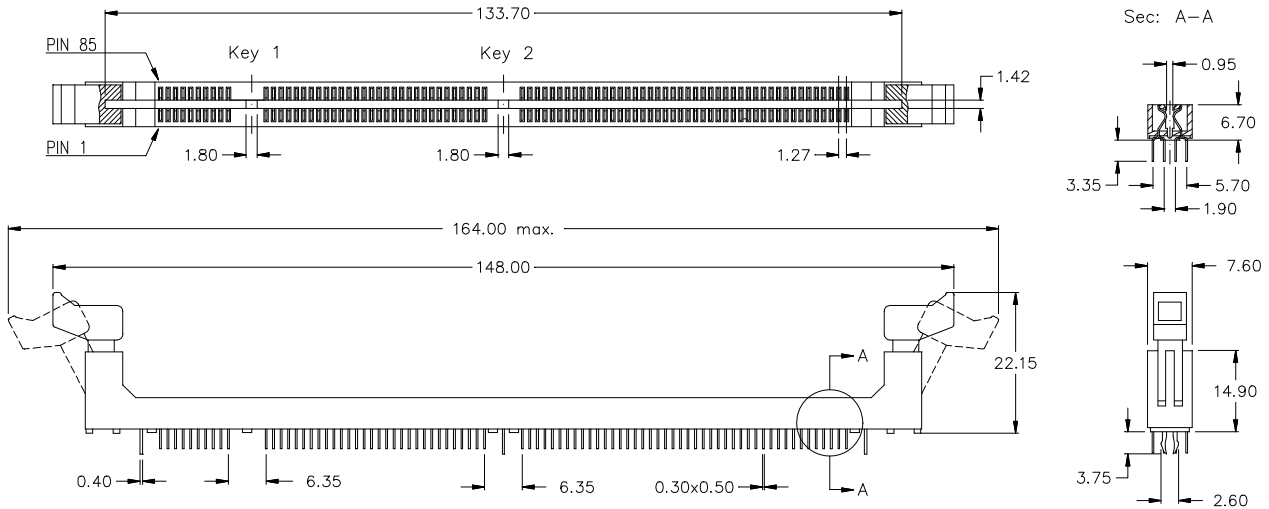

PC Board hole layout

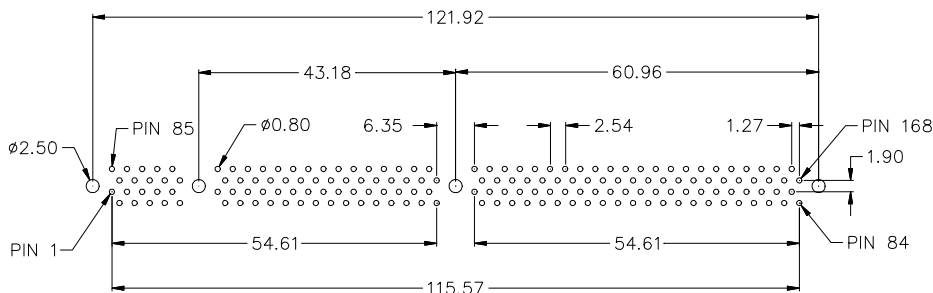

Module keying Type "A"

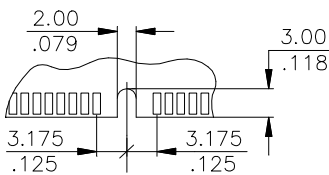

Module keying Type "B"

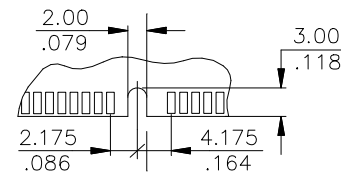

Module keying Type "C"

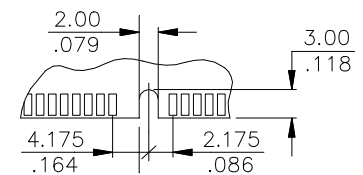

Specification

Current rating	1 A max., 250V AC	Operating temperature	-55° C to +105° C min.
Contact resistance	30 mΩ max.	Insulator (RoHS compliant)	high temp plastic UL 94 V-0
Breakdown voltage	1,5 KV RMS max.	Contact (RoHS compliant)	Copper Alloy
Insulation resistance	10 ⁴ MΩ min.	Plating	Au / Sn (leadfree) over Ni
Capacitance	1 pF max.		

Pin	Socket Type	Key No. 1	Key No. 2	Ordering Code
168 pin	DRAM 5 Volt	Type "A"	Type "B"	DM1 - 168 - VAB9 - 95/1L
168 pin	SDRAM 5 Volt	Type "B"	Type "B"	DM1 - 168 - VBB9 - 95/1L
168 pin	UDRAM 5 Volt	Type "C"	Type "B"	DM1 - 168 - VCB9 - 95/1L
168 pin	DRAM 3,3 Volt	Type "A"	Type "A"	DM1 - 168 - VAA9 - 95/1L
168 pin	SDRAM 3,3 Volt	Type "B"	Type "A"	DM1 - 168 - VBA9 - 95/1L
168 pin	UDRAM 3,3 Volt	Type "C"	Type "A"	DM1 - 168 - VCA9 - 95/1L

DR - Series DIMM Sockets

for DDR Module vertical type 184-pin



DIMM sockets for DDR module are only available as long latch type (Module locking extractors).

Insertion & extraction of the module can be made without any tools.

Positive polarization prevents wrong insertion of the module.

Contacts are designed with an anti-overstress feature for long contact life. Selective Gold/Tin plated. Gold only in contact area.

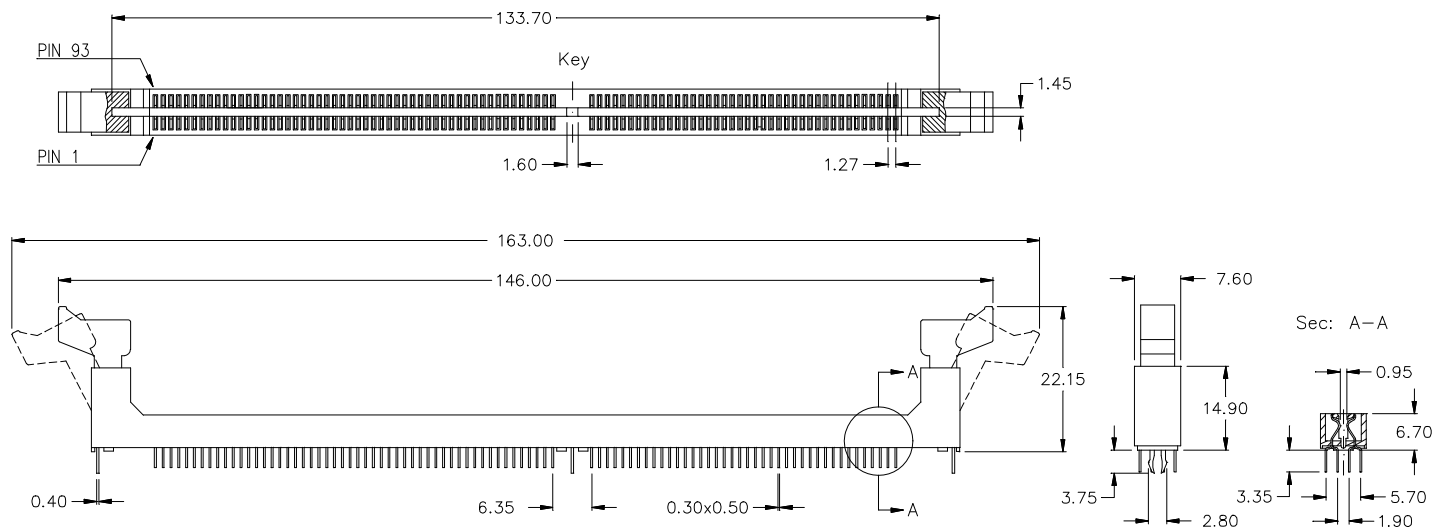

PC Board hole layout

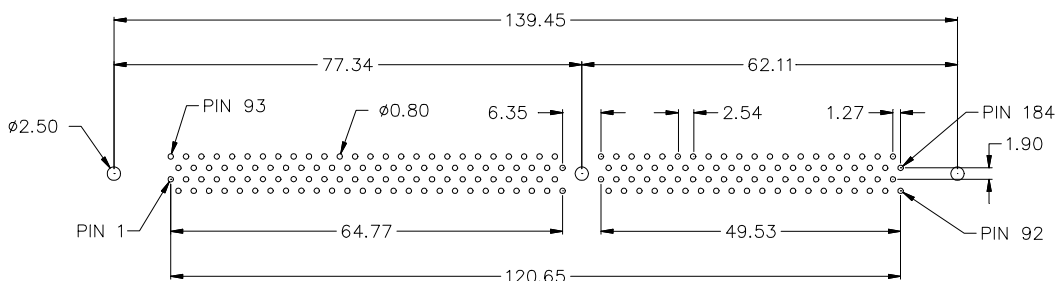

Module keying Type "A"

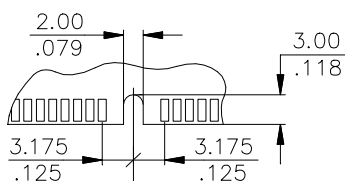

Module keying Type "B"

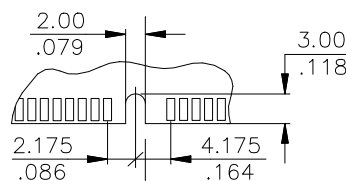

Module keying Type "C"

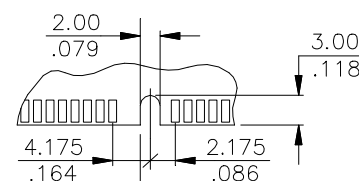

Specification

Current rating 1 A max., 250V AC
 Contact resistance 30 mΩ max.
 Breakdown voltage 1,5 KV RMS max.
 Insulation resistance 10⁴ MΩ min.
 Capacitance 1 pF max.

Operating temperature -55° C to +105° C min.
 Insulator (RoHS compliant) high temp plastic UL 94 V-0
 Contact (RoHS compliant) Copper Alloy
 Plating Au / Sn (leadfree) over Ni

Pin	Socket Type	Voltage Key	Ordering Code
184 pin	1,8 Volt	Type "A"	Please contact E-tec sales office for availability.
184 pin	2,5 Volt	Type "B"	DR1 - 184 - VBZ9 - 95/1L
184 pin	3,3 Volt	Type "C"	Please contact E-tec sales office for availability.