

2,54mm pitch **SMT** female header with precision „Jumbo Contact“ for board to board connections.

Accepts square pins 0,65 x 0,65mm max. (Pin Headers), as well as round pins \varnothing 0,65 to 0,85mm max.

The female headers are available in any number of contacts, up to a maximum of 50 for the single row, and 100 for the double row.

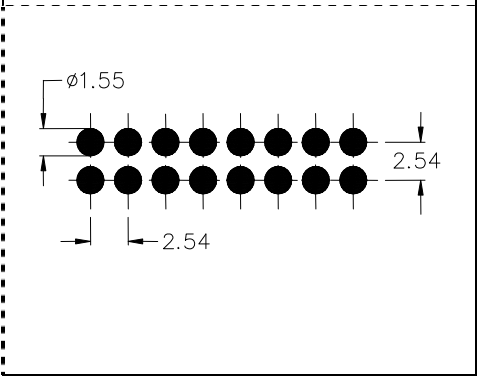
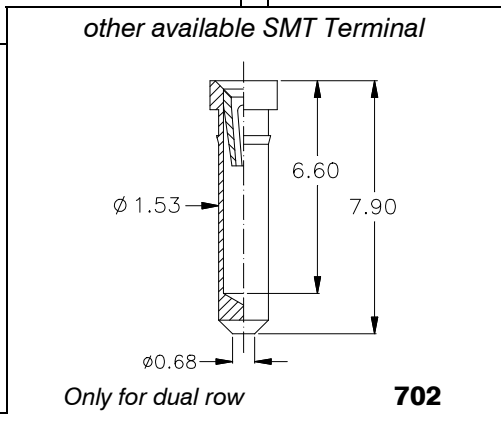
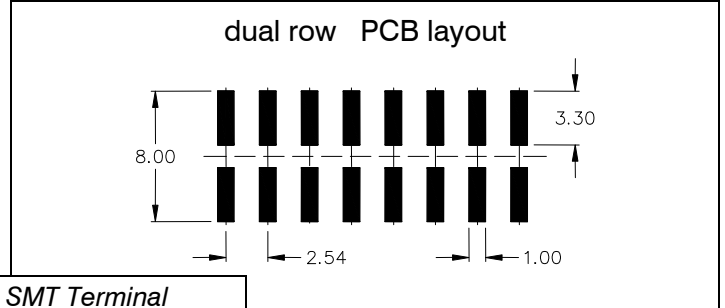
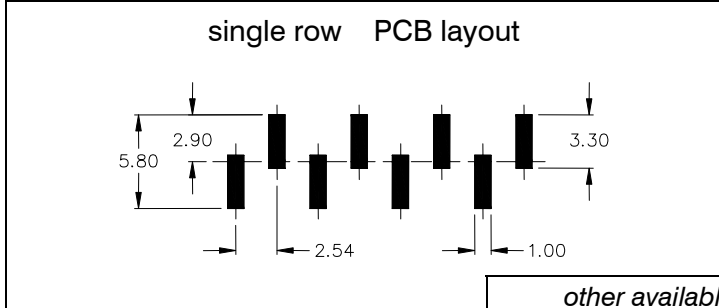
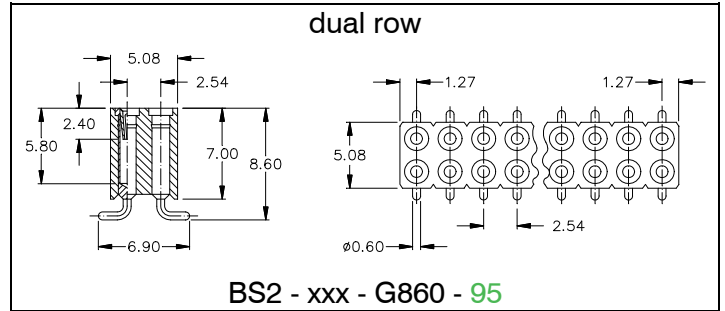
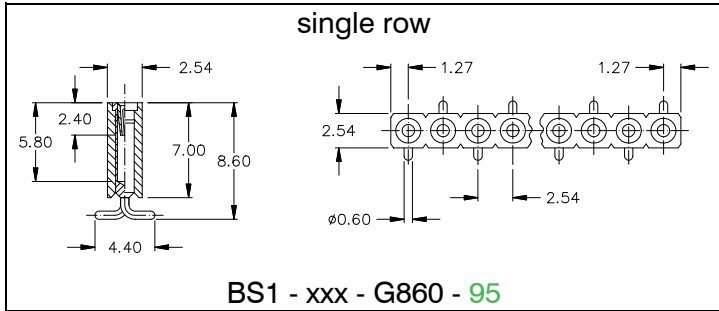
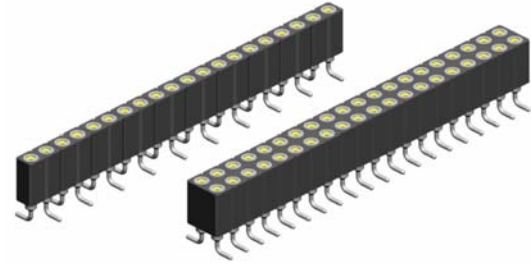

Specifications

Mechanical data

Insertion force (test probe \varnothing 0,66)	2,00 N if Terminal 860
Extraction force (test probe \varnothing 0,66)	1,00 N for all Terminals
Contact life	> 100 cycles
Operating temperature	-55° C to +125° C
Processing Temperature	+250°C +0/-5°C for 20~40sec.

Material

Insulator	(RoHS compliant) high temp plastic UL 94 V-0
Terminal	(RoHS compliant) CuZn
Contact	(RoHS compliant) BeCu

Electrical data

Insulation resistance	10 ⁴ M Ω min.
Breakdown voltage	500 V AC for 1 minute
Contact resistance	30 m Ω / contact max.
Current rating	3 A max., 100V

Insertion depth

maximum	depends on the Terminal style
minimum	4,0mm / .157"

How to order

BSX - xxx - G xxx - xx

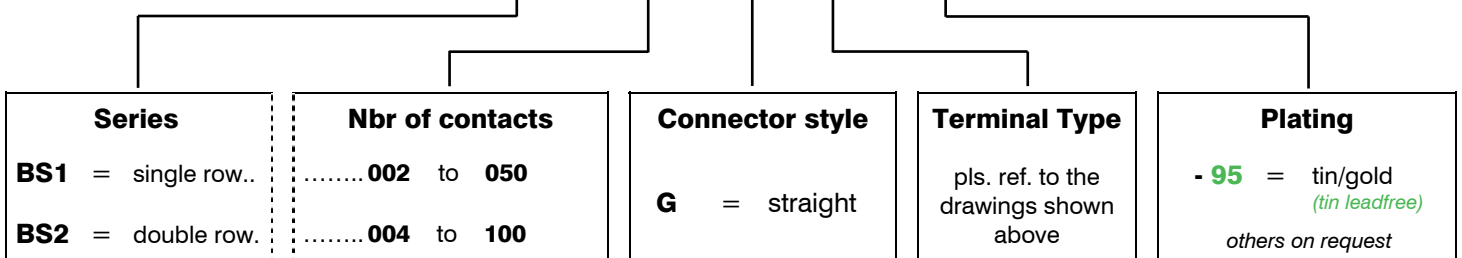

2,54mm pitch “**low profile**” SMT female header with precision „Jumbo Contact“ for board to board connections.

Accepts square pins 0,65 x 0,65mm max. (Pin Headers), as well as round pins \varnothing 0,65 to 0,85mm max.

The female headers are available with 40 contacts max. for the single row, and 80 (2x40) max. for the dual row.

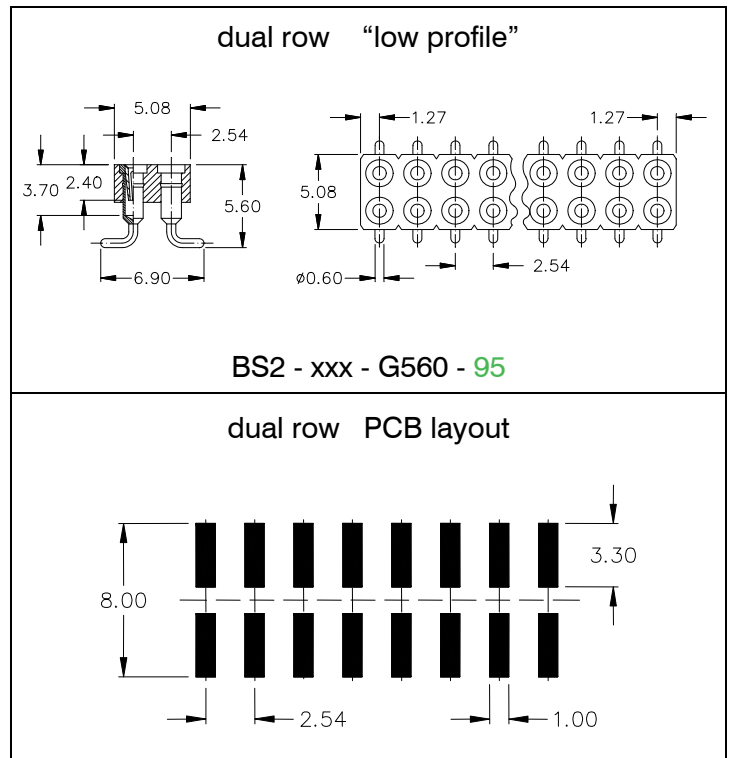
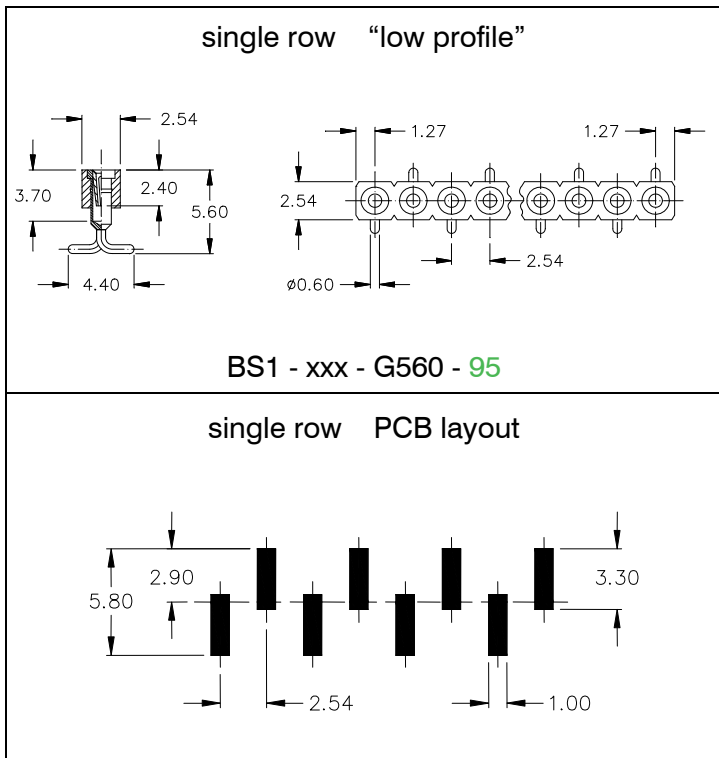
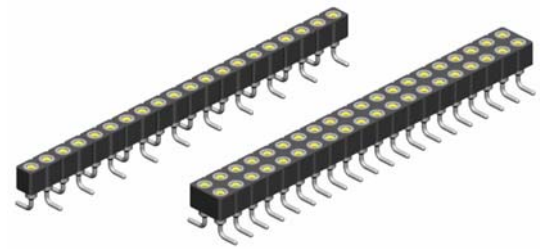

Specifications

Mechanical data

Insertion force	1,40 N (avg) (test probe \varnothing 0,66)
Extraction force	0,25 N (avg) (test probe \varnothing 0,66)
Contact life	> 100 cycles
Operating temperature	-55° C to +125° C
Processing Temperature	+250°C +0/-5°C for 20~40sec.

Material

Insulator	(RoHS compliant) high temp plastic UL 94 V-O
Terminal	(RoHS compliant) CuZn
Contact	(RoHS compliant) BeCu

Electrical data

Insulation resistance	10 ⁴ M Ω min.
Breakdown voltage	500 V AC for 1 minute
Contact resistance	30 m Ω / contact max.
Current rating	3 A max., 100V

Insertion depth

maximum	3.70mm / .146"
minimum	3.00mm / .118"

How to order

BSx - xxx - G560 - 95

Series	Nbr of contacts	Connector style	Terminal Type	Plating
BS1 = single row.. BS2 = dual row.... 002 to 040 004 to 080	G = straight	pls. ref. to the drawings shown above	- 95 = tin/gold (tin leadfree) others on request

General Specifications for Precision Pin Sockets

Mechanical data

Average forces for available clip types:	
Standard type	1.80N insertion / 0.90N extraction
Low force type	0.70N insertion / 0.25N extraction
Super low force type	0.40N insertion / 0.15N extraction
High force type	4.00N insertion / 2.50N extraction
„Jumbo“ contact	1.40N insertion / 0.25N extraction
<i>Other clips and forces available on request</i>	
Contact life	min. 100 cycles
Vibration as per EN60352-4	sinusoidal, 10 to 500 Hz, 10g, 1 octave/min, 10 cycles for each axis
Shock as per EN60352-4	half sine, 50g, 11ms, 3 shocks in 3 axes
Thermal shock as per IEC 60068-2-14	-55°C/+125°C, 5 cycles, 30 minutes
Solderability as per IEC 60068-2-58	245°C to 255°C 5 sec; Sn97Ag3 solder alloy
Dry heat steady state as per IEC 60068-2-2	260°C for 20 sec.
Cold steady state as per IEC 60068-2-1	-55°C, 2h
Damp heat cyclic as per IEC 60068-2-30	55°C, 90-100%rH, 24h
Moisture sensitivity Level (JEDEC J-STD-020C)	2 for PBT & Nylon 1 for all other materials
PCB holes for 2.54mm pitch standard connectors	1.00mm diameter
Coplanarity thru-hole	0.30mm
General tolerances	+/- 0.10mm

Operating temperature (standard)

-55°C to +125°C

Processing temperature

injection molded insulator (high temp)	+250°C +0/-5°C for 20~40 sec. (reflow solder)
injection molded insulator (PBT)	+250°C +0/-5°C for 10 sec. (wave solder only)
Epoxy FR4 (Standard)	+220°C min. for 10 sec.
Epoxy FR4 (hi temp)	+260°C min. for 60 sec.

Electrical data

Contact resistance at 1A	4,3 mΩ typ.
Current rating (except „Jumbo“ contact)	1A max.
„Jumbo“ contact	3A max.
Contact capacitance at 1MHz	2pF max.
Insulation resistance at 500V DC for std & hi-temp	5 × 10 ⁹ Ω min.
Insulation resistance at 500V DC for FR4 Epoxy	> 10 ⁴ MΩ
Breakdown voltage at 60 Hz	500 V AC min.
Contact resistance after 1000 ins./ext. cycles	≤ 7 mΩ

Material (RoHS compliant)

Standard temperature plastic: PBT UL 94 V-0	14, 15, 16, 23, 17, 19, 20, 24 25, 26, 27, 29
High-temp plastic: Nylon, PCT, SPS, PPS, LCP UL 94 V-0	5, 6, 7, 8, 9, 10, 11, 12, 13, 14 15, 16, 21, 22, 20, 25, 26, 27 28, 33, 34, 35, 36, 37, 38, 39 40, 41, 42, 43
Epoxy FR4: UL 94 V-0 & UL 94 V-1	32, 5, 6, 7, 18, 22, 24, 29
PBT, Nylon, PCT, SPS, PPS, LCP & Epoxy FR4	If necessary pls. contact E-tec for Material specification.
Terminal: CuZn	
Contact: BeCu	

Male pin dimensions for standard clip (except „Jumbo Contact“)

(DIN 41 870, IEC 191 for square IC-legs)

DIM	min.	max.
„A“ ∅	<u>0,42</u> .016"	<u>0,56</u> .022"
„B“ □	<u>0,36</u> .014"	<u>0,55</u> .023"
„C“ □	<u>0,20</u> .008"	<u>0,30</u> .014"

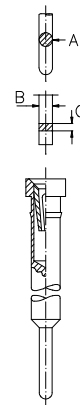

General information concerning the E-tec interconnect products

Plating:

- Standard tin plating:
min. 2.50µm Sn (*leadfree*) over Ni
- Standard gold plating:
flash, max. 0,10µm Au over Ni
- Higher gold platings are offered on request

Specifications:

The data contained in this catalog is of general nature and refers to standard products. For example a „Current rating“ at an ambient temperature of 25° C reflects the value per individual contact. Should you require any further data or test reports, you can obtain this information from your nearest E-tec sales office.

The E-tec connectors conform with signal integrity requirements at high data and frequency rates. However we cannot offer a general information about the max. frequency or data transmission rate. For such a statement, it would require more information about the chosen configuration and pin-out, the length of the cable and/or any other specific requirements regarding the application itself and its related signal integrity.

E-tec SMT connectors, male or female, are offered with a coplanarity of max. 0,10mm. They are adapted to all modern SMT soldering processes and they can be handled easily with all currently existing placing techniques. Customers may choose between various packaging options, such as tray, tube and tape & reel.

GENERAL POLICY

All information contained in this catalog, including illustrations, specifications and dimensions are accurate to the best of our knowledge, and reflect the status as at the date of publication. Due to technical progress, it is subject to change without notice. Application information is informational in nature and shall not be construed to warrant suitability of products for any particular purpose as performance may vary depending on the conditions to which a product is subjected. Unless otherwise confirmed at the time of order, all E-tec products are non cancellable and non returnable items (NCNR). E-tec products are warranted for 30 days and the warranty is limited strictly to replacement of products. This warranty does not cover any claims for natural wear and tear, nor for any compensations, such as loss of production, loss of use, loss of orders, loss of profit, nor any other direct or indirect damages.